

B-B
2:1

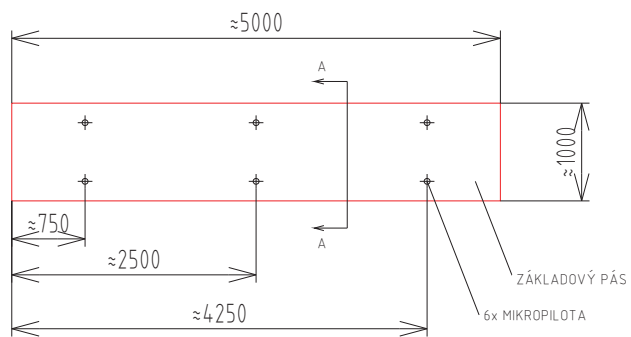

A-A
5:1

